

Operating Guide

VS 2 DN 15-25



MAINTENANCE
FREE



VI.0816.1/02

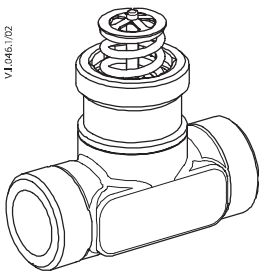

VS 2

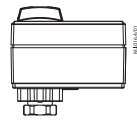

AMV(E) 10 +
VS 2 DN 15-25

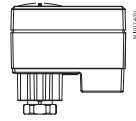

AMV(E) 13 +
VS 2 DN 15-25

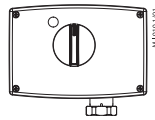

AMV(E) 20/30, 23/33 +
VS 2 DN 15-25

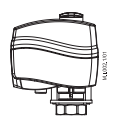

AMV 150 +
VS 2 DN 15

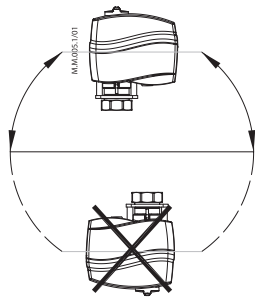
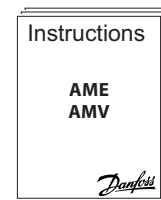

IP 54
AMV 150

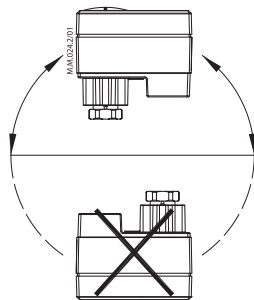

IP 54
AMV(E) 13

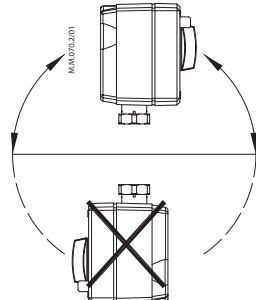

IP 54
AMV(E) 20/30, 23/33

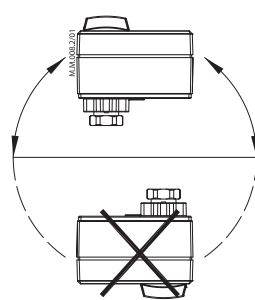

IP 54
AMV(E) 10

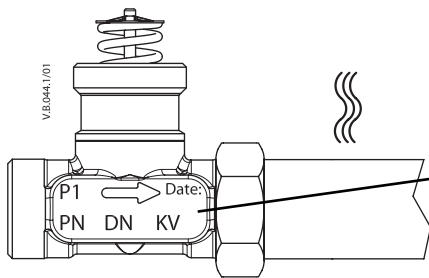

P1 → Date:
PN DN KV

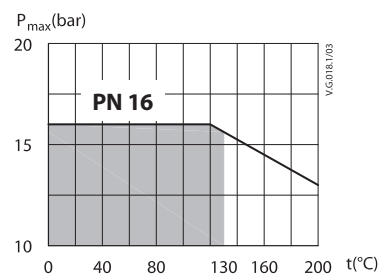

VS 2

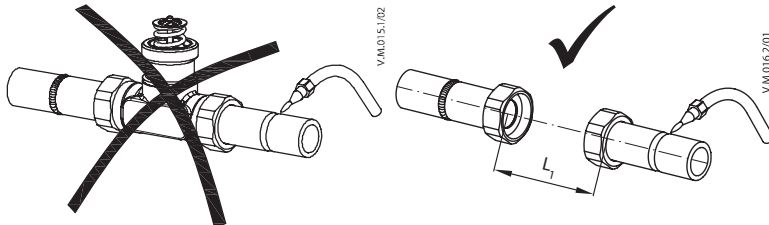
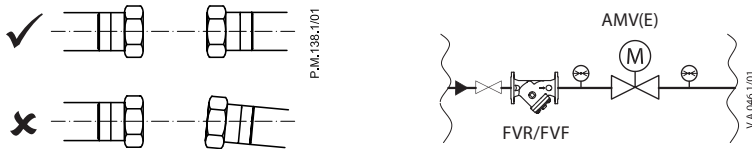

DN	L_1
	mm
15	69
20	74
25	79

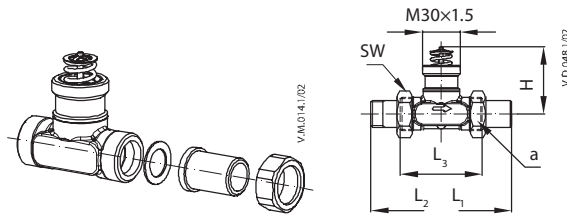
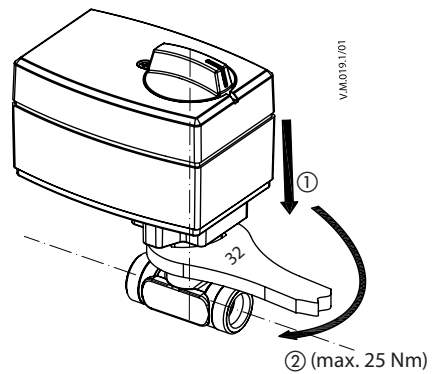
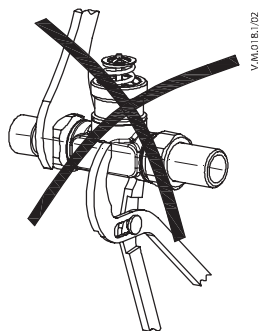
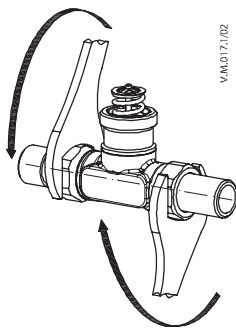

DN	L_1	L_2	L_3	H	a	SW
	mm				ISO 228/1	(mm)
15	139	131	65	54	G 3/4A	32
20	154	142	70	58	G 1A	41
25	159	159	75	58	G 1 1/4A	46

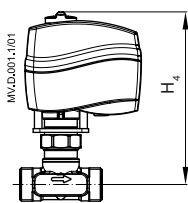

AMV 150 +
VS 2 DN 15

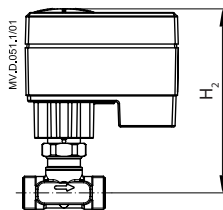

AMV(E) 13 +
VS 2 DN 15-25

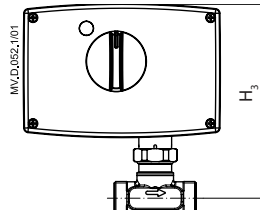

AMV(E) 20/30, 23/33 +
VS 2 DN 15-25

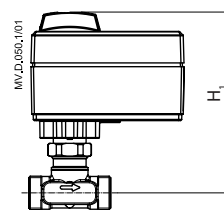

AMV(E) 10 +
VS 2 DN 15-25

DN	H_1	H_2	H_3	H_4
	15	142	145	155
20	149	152	162	-
25	155	158	168	-

Type	AMV 150	AMV 10/13	AME 10/13	AMV(E) 20/23	AMV(E) 30/33
VS 2 DN 15	•	•	-	-	-
VS 2 DN 20	-	•	•	•	•
VS 2 DN 25	-	•	•	•	•

Danfoss can accept no responsibility for possible errors in catalogues, brochures and other printed material. Danfoss reserves the right to alter its products without notice. This also applies to products already on order provided that such alterations can be made without subsequent changes being necessary in specifications already agreed. All trademarks in this material are property of the respective companies. Danfoss and the Danfoss logotype are trademarks of Danfoss A/S. All rights reserved.