

Installation Guide

AHQM, DN 15-32

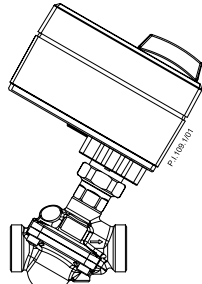

AMV(E) 10 +
AHQM

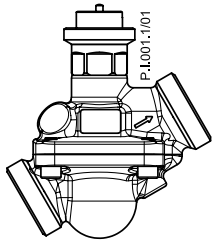
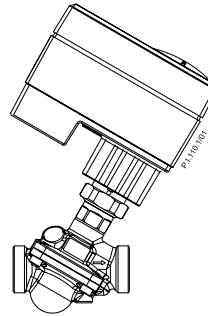

AMV(E) 13 +
AHQM

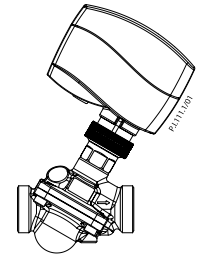

AMV(E) 130(H)/140(H) +
AHQM

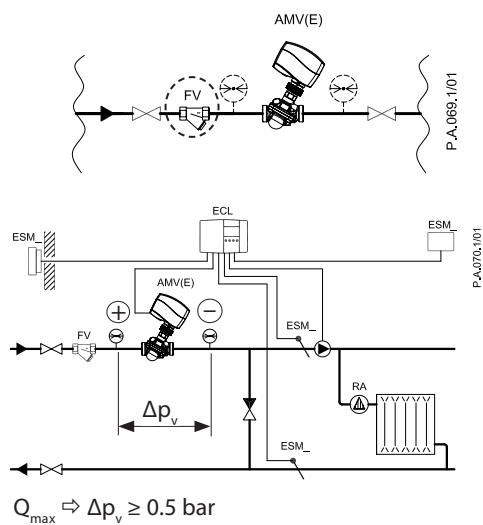
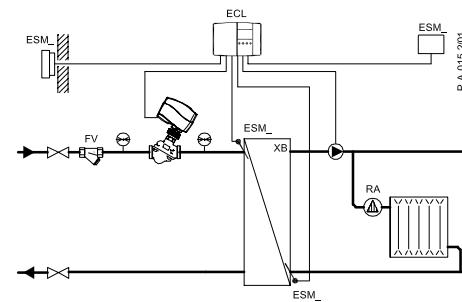
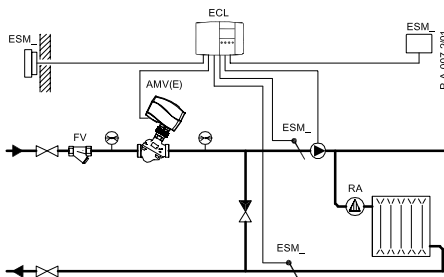
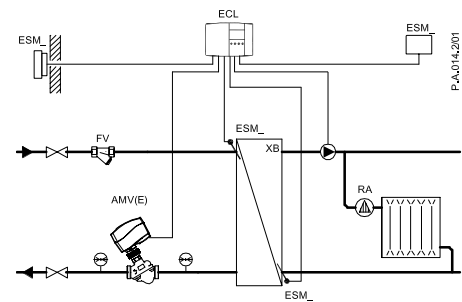
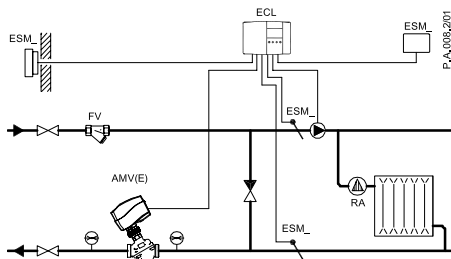

max. t: 120 °C
min. t: 2 °C

max. PN: 16 bar

max. P_{test}: 24 bar

P_{test} = 1.5 × PN

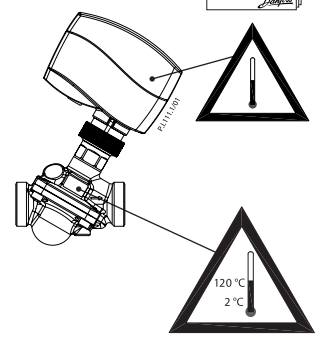
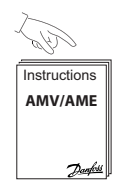

Installation Guide AHQM, DN 15-32

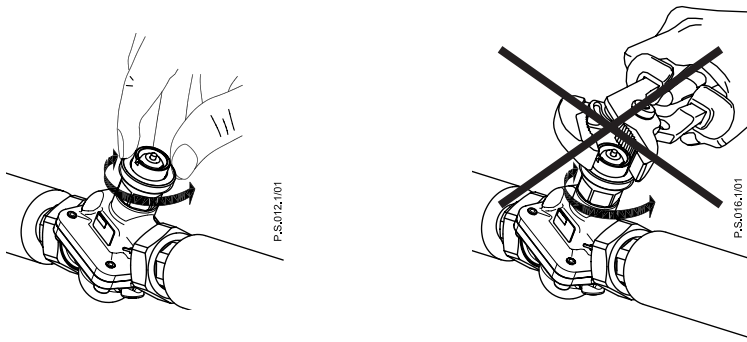

1

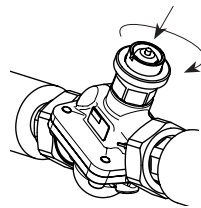
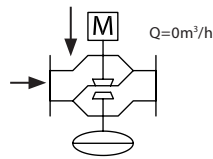

2

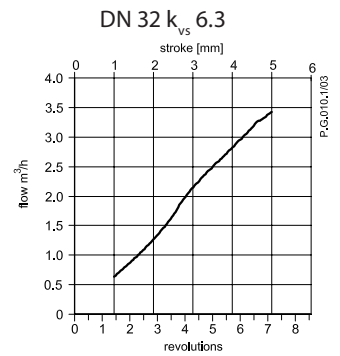
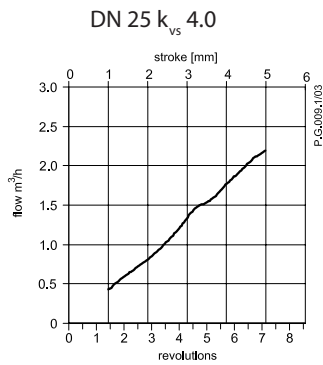
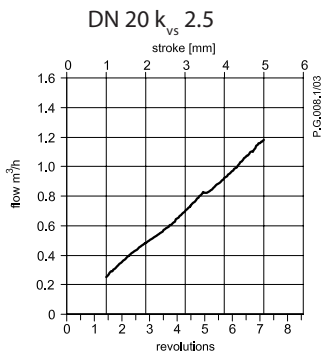
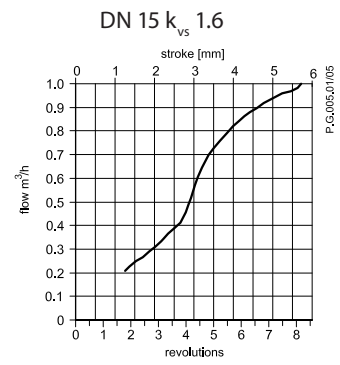
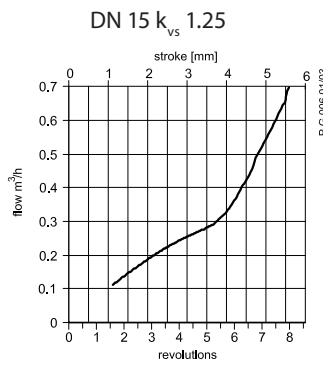
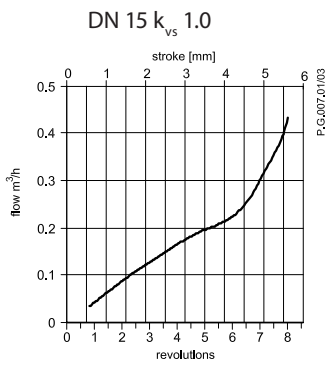
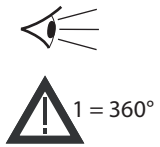

3

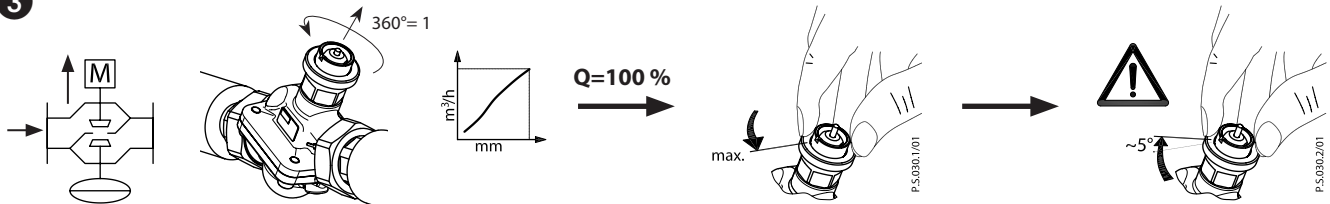

Installation Guide AHQM, DN 15-32

DN	L (mm)
15	69
20	74
25	79
32	104

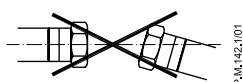
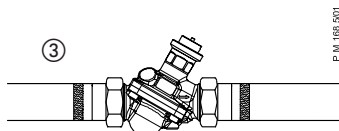
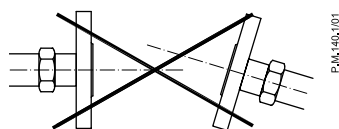
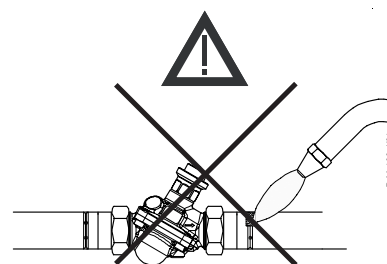
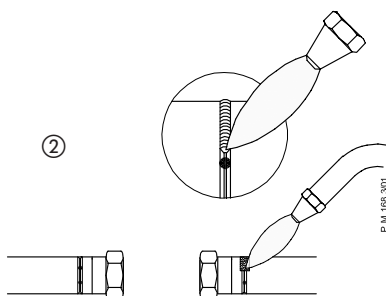
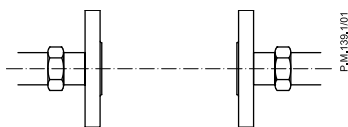
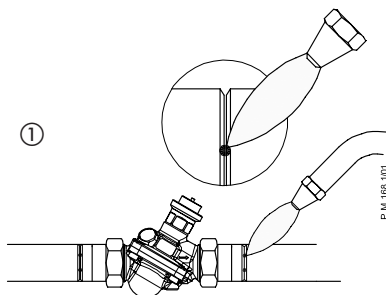
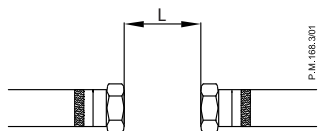

AMV(E) 10, 13

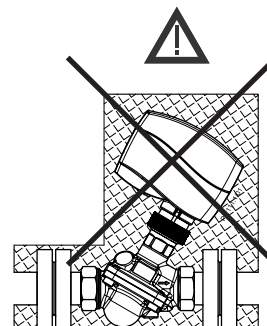
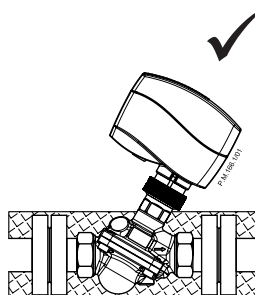
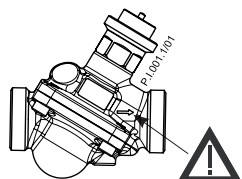
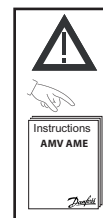
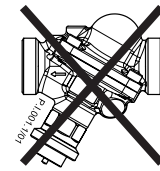
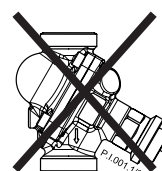
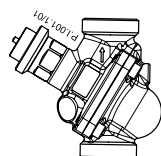
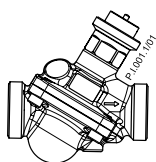
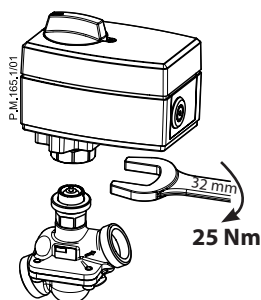

Installation Guide AHQM, DN 15-32

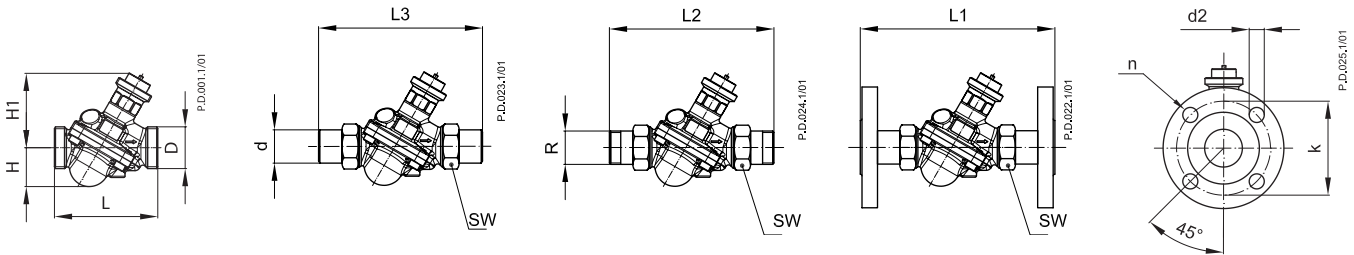

DN		15	20	25	32
SW		32 (G ¾A)	41 (G 1A)	50 (G 1¼A)	63 (G 1¾A)
d		21	26	33	42
R ¹⁾		½	¾	1	1 ¼
L		65	82	104	130
L1 ²⁾		130	150	160	-
L2		131	144	160	177
L3	mm	139	154	159	184
H		24	31	39	49
H1		57	59	72	84
D (ISO 228/1)		G ¾ A	G 1 A	G 1¼ A	G 1¾ A
k		65	75	85	-
d ₂		14	14	14	-
n		4	4	4	-
Valve weight	kg	0.51	0.67	1.47	2.23

¹⁾ EN 10226-1
²⁾ EN 1092-2

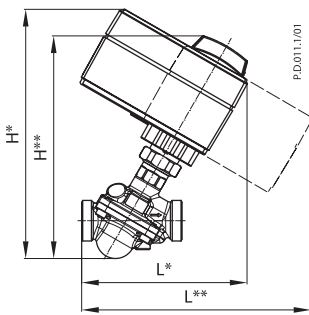

AMV(E) 10 + AHQM

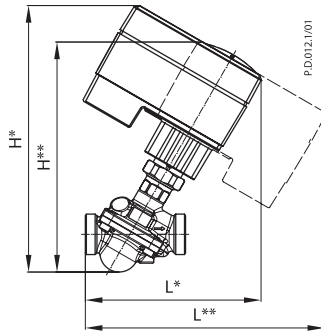

AMV(E) 13 + AHQM

DN		15	20	25	32
L*	AMV(E) 10	137	137	153	172
	AMV(E) 13	147	147	164	183
L**	AMV(E) 10	178	186	204	224
	AMV(E) 13	188	196	214	234
H*	AMV(E) 10	195	201	223	245
	AMV(E) 13	210	216	238	260
H**	AMV(E) 10	174	184	202	222
	AMV(E) 13	180	190	208	228

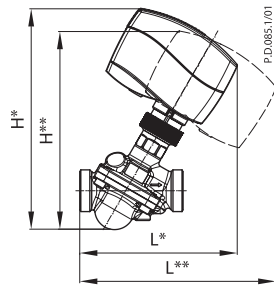

AMV(E) 130(H)/140(H) + AHQM

DN		15	20	25	32
L*		118	125	141	160
L**	mm	148	156	174	194
H*		168	178	196	216
H**		152	162	180	200

Danfoss can accept no responsibility for possible errors in catalogues, brochures and other printed material. Danfoss reserves the right to alter its products without notice. This also applies to products already on order provided that such alterations can be made without subsequent changes being necessary in specifications already agreed. All trademarks in this material are property of the respective companies. Danfoss and the Danfoss logotype are trademarks of Danfoss A/S. All rights reserved.